

# EFFICIENT REMOVAL OF LIGHT AND MEDIUM SOILING

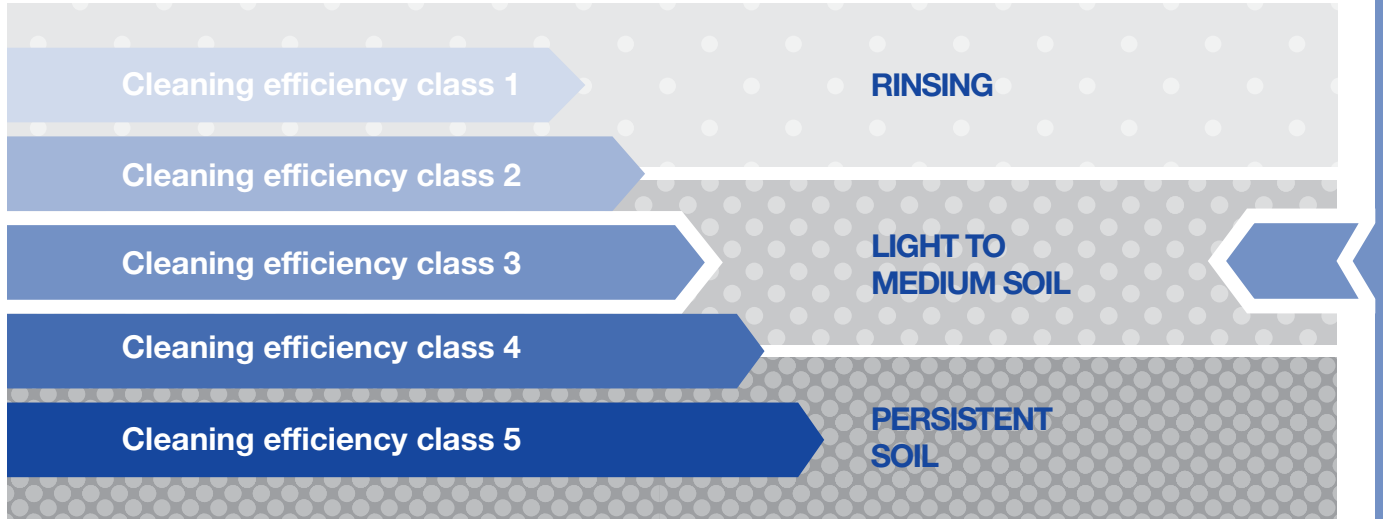

## Cleaning efficiency class 3

Due to their special nozzle geometry and flow rates from 11 to 639 l/min at 2 bar, the rotating nozzles in efficiency class 3 are suitable for cleaning medium soiling from tanks and equipment. Such soiling is especially found in the food and beverage industry, but also in the chemical and pharmaceutical industry. The free-spinning rotating nozzles in class 3 are made from especially high-grade materials and are available in tank sizes from small to large.

The HygienicWhirly is perfectly suited for hygienically sensitive areas and can also be used for the output of foam.

The Whirly series is also available as an ATEX version and can therefore also be used in explosive environments.



 <b>Max. tank diameter [m]</b>	0	1	2	3	4	5	6	7	8
---	---	---	---	---	---	---	---	---	---

 **Operating principles**  
Free-spinning

 **Flow rates at 2 bar**  
11 to 639 l/min

 **Recommended operating pressures**  
2 to 3 bar

 **Max. temperatures**  
90 to 140 °C



# Rotating cleaning nozzles »HygienicWhirly« Series 594/595

## Series 594/595

The HygienicWhirly with its highly effective flat jets is particularly suited for high hygiene requirements and for the application of foam. Operation at low pressure with good cleaning effect is also possible.



	<b>Max. tank diameter [m]</b>	0	1	2	3	4	5	6	7	8
--	-------------------------------	---	---	---	---	---	---	---	---	---

**Materials**  
316L SS, PEEK,  
Slip-on connection  
version: O-ring made  
of EPDM

**Max. temperature**  
100 °C,  
short-term  
up to 140 °C

**Recommended  
operating pressure**  
3 bar

**Installation**  
Operation in every  
direction is possible

**Filtration**  
Line strainer with  
a mesh size of  
0.3 mm/50 mesh

**Bearing**  
Slide bearing  
made of PEEK

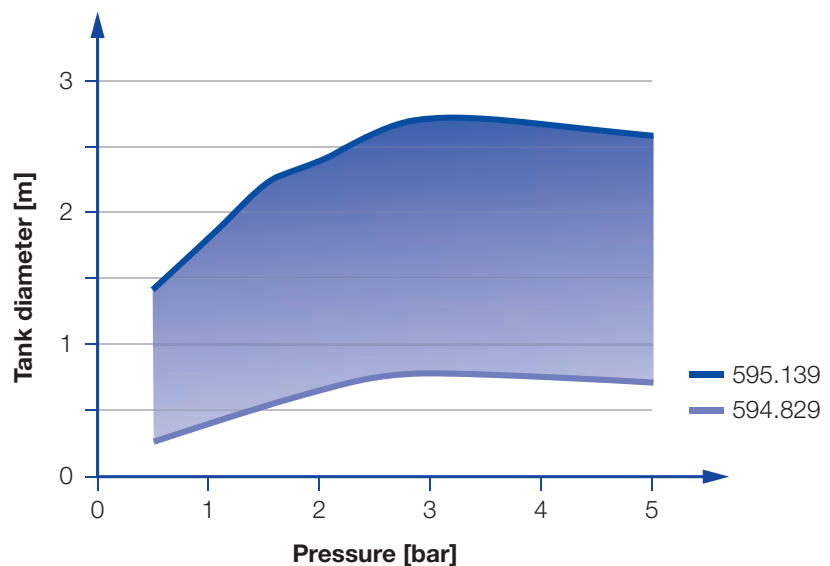

Overview of the tank diameter, depending upon the pressure of series 594/595

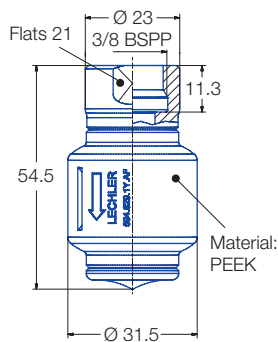

**Standard version  
Female tread  
59X.XX9.1Y.AF**

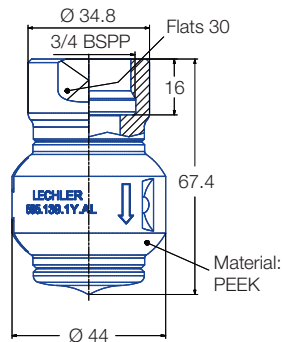

**Standard version  
Female tread  
595.139.1Y.AL**

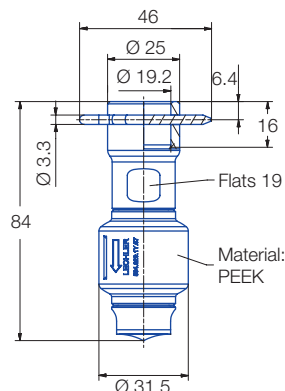

**Dimensions slip-on connection  
according to ASME-BPE (OD-tube)  
59X.XX9.1Y.67**

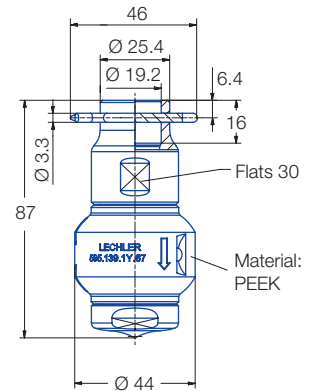

**Dimensions slip-on connection  
according to ASME-BPE (OD-tube)  
595.139.1Y.67**

Spray angle	Ordering no.				E Ø [mm]	V̇ [l/min]					Max. tank diameter [m]
	Type	Connection				p [bar] (p <sub>max</sub> = 5 bar)					
		3/8 BSPP female	3/4 BSPP female	3/4" Slip-on		0.5	1	2	3	at 40 psi [US gal/min]	
360°	594.829.1Y	AF	-	67	1.7	6	8	11	14	3	0.8
	594.879.1Y	AF	-	67	2.5	8	11	15	18	5	1.2
	595.009.1Y	AF	-	67	4.0	16	22	32	39	10	1.5
	595.049.1Y	AF	-	67	4.2	20	28	40	49	12	2.0
	595.139.1Y	-	AL	67	5.0	34	47	67	82	21	2.7

E = narrowest free cross-section · NPT on request

**The maximum tank diameter shown above applies for the recommended operating pressure and is indicative only. The cleaning result is also affected by the type of soiling.**

### Information on operation

- Operation with compressed air only for short-term usage. Operation above the recommended operating pressure has negative effects on the cleaning result and wear.

**Example of ordering:** Type 594.829.1Y + Connection AF = Ordering no. 594.829.1Y.AF

### Slip-on information

- R-clip made of 316L SS is included (Ordering no.: 095.022.1Y.50.94.E).
- Depending on diameter of the adapter the flow rate can increase due to leakage between connecting pipe and rotating cleaning nozzle.



# Rotating cleaning nozzle »Whirly 2« Series 5W9

**NEW**

## Series 5W9

Popular and proven: the design of the Whirly 2. It generates effective flat jets, offers various connection options and is available in a very wide range of flow rates. It is also available in an ATEX-approved version and in a range of versions with different spray angles.

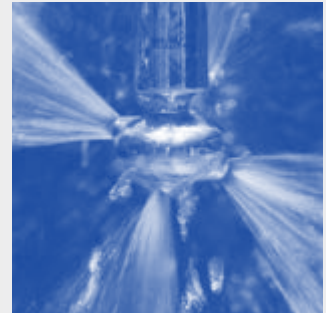

Function video  
[www.lechler.com/de-en/medialibrary](http://www.lechler.com/de-en/medialibrary)  
Or scan the QR Code.



**Max. tank diameter [m]**

0 | 1 | 2 | 3 | 4 | 5 | 6 | 7 | 8



**Materials**  
316L, PEEK



**Max. temperature**  
140 °C



**Recommended operating pressure**  
2 bar



**Installation**  
Operation in every direction is possible



**Filtration**  
Line strainer with a mesh size of 0.1 mm/170 Mesh



**Bearing**  
Double ball bearing made of 316L



**Adapter**  
3/4 BSPP is compatible with HygienicFit

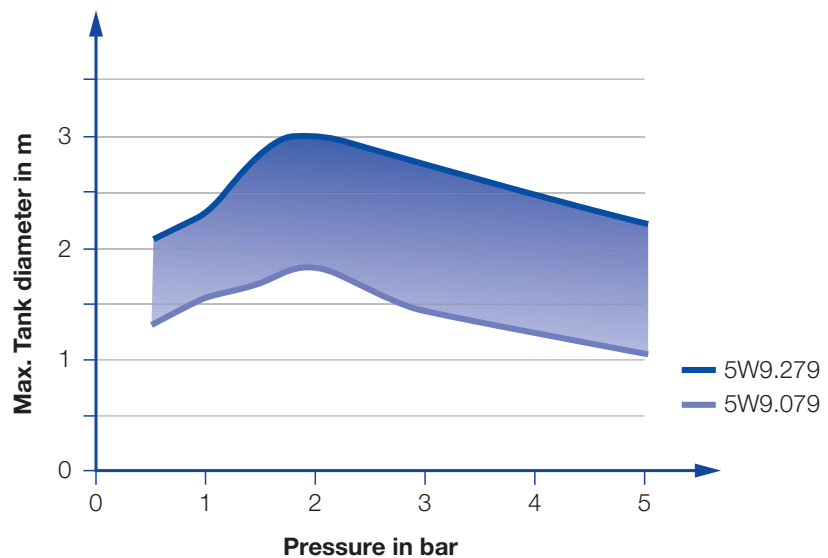

Overview of the maximum tank diameter, depending upon the pressure of series 5W9

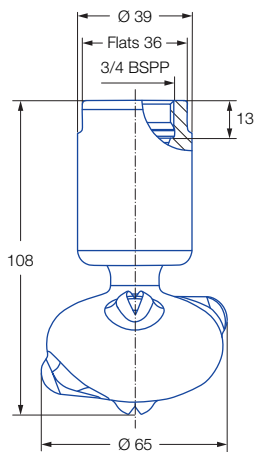

Female thread

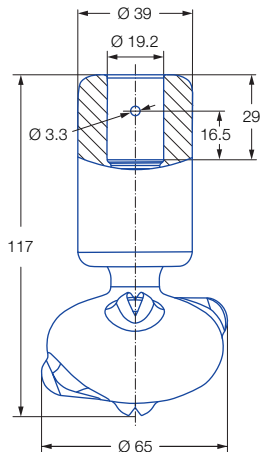



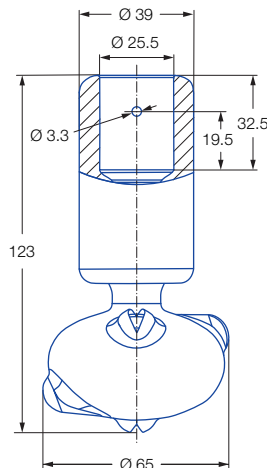

Dimensions of the 3/4" slip-on connection according to ASME-BPE (OD-tube)

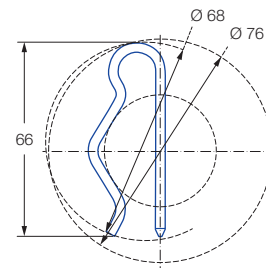

Dimensions of the 1" slip-on connection according to ASME-BPE (OD-tube)



Dimensions slip-on connection top-view

Spray angle 	Ordering no.				E Ø [mm]	V [l/min]				Max. tank diameter [m]
	Type	Code				p [bar] (p <sub>max</sub> = 6 bar)				
		3/4 BSPP	3/4" Connection	1" Connection		1	2	3	at 40 psi [US gal./min]	
270° 	5W9.075.1Y	AL	TF07	TF10	2.0	34	48	59	15	1.8
	5W9.145.1Y	AL	TF07	TF10	2.8	50	71	87	22	2.1
	5W9.195.1Y	AL	TF07	TF10	3.3	69	97	119	30	2.6
270° 	5W9.076.1Y	AL	TF07	TF10	2.0	34	48	59	15	1.8
	5W9.106.1Y	AL	TF07	TF10	2.5	41	58	71	18	2.1
	5W9.196.1Y	AL	TF07	TF10	3.4	69	97	119	30	2.6
360° 	5W9.079.1Y	AL	TF07	TF10	1.6	34	48	59	15	1.8
	5W9.149.1Y	AL	TF07	TF10	2.4	50	71	87	22	2.1
	5W9.199.1Y	AL	TF07	TF10	3.0	69	97	119	30	2.6
	5W9.279.1Y	AL	TF07	TF10	3.5	103	145	178	45	3.0

E = narrowest free cross-section · NPT on request

The maximum tank diameter shown above applies for the recommended operating pressure and is indicative only. The cleaning result is also affected by the type of soiling.

### Information on operation



- Operation with compressed air only for short-term usage. Operation above the recommended operating pressure has negative effects on the cleaning result and wear.

### Slip-on information

- Split pin made of 316L SS is included (Ordering no.: 095.022.1Y.06.72.0).
- Depending on diameter of the adapter the flow rate can increase due to leakage between connecting pipe and rotating cleaning nozzle.
- Minimum insertion diameter (with mounted split pin) is 68 mm.

**Example of ordering with ATEX approval. FDA and (EC) 1935/2004 conform.**



**Unit group/category/zones:**  
 ☉ II 1G Ex h IIB T6...T3 Ga  
 ☉ II 1D Ex h IIIC T85 °C...T170 °C Da

**Ordering Type + Connection = Ordering no.**  
 example: 5W9.075.1Y.XX.EX + AL = 5W9.075.1Y.AL.EX

**Example of ordering with FDA and (EC) 1935/2004 conformity.**

**All Materials are suitable for contact with food.**

**Ordering Type + Connection = Ordering no.**  
 example: 5W9.075.1Y.XX + AL = 5W9.075.1Y.AL

**Attention:** for the ATEX version of the slip-on connection the code for the connection changes. Ordering example for connection TF.07: 5W9.075.1Y.T2.EX/ ordering example for connection TF.10: 5W9.075.1Y.T3.EX



# Rotating cleaning nozzles »Gyro« Series 577

## Series 577

The Gyro cleans with powerful nozzle inserts and is available in many flow rates and spray angles. It is also suitable for very large tanks and is insensitive to clogging.

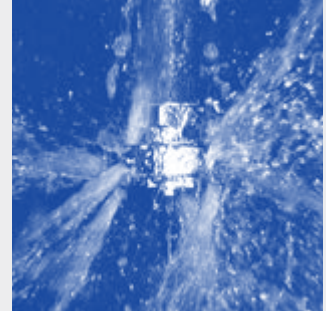

**Function video**  
Scan the QR-code or go to:  
[www.lechler.com/gyro](http://www.lechler.com/gyro)



**Max. tank diameter [m]**



**Materials**  
316L SS, PTFE



**Max. temperature**  
90 °C



**Recommended operating pressure**  
3 bar



**Installation**  
Vertically facing downward



**Filtration**  
Line strainer with a mesh size of 0.3 mm/50 mesh



**Bearing**  
Slide bearing made of PTFE



**Accessories**  
Spare parts set consisting of:  
top seal, bottom seal, bolt, nut, sleeve, instructions for use

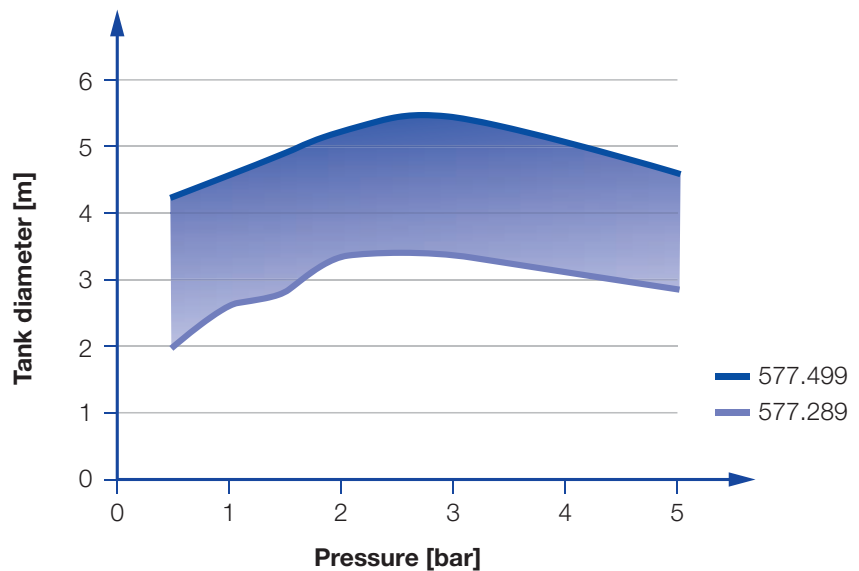

Overview of the tank diameter, depending upon the pressure of series 577

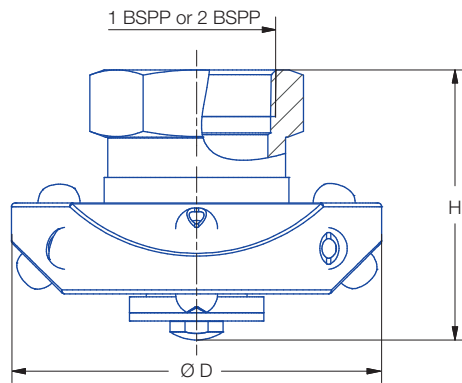

Female thread

Spray angle	Ordering no.			V̇ [l/min]					Dimensions		Max. tank diameter [m]
	Type	Connection		p [bar] (p <sub>max</sub> = 5 bar)					Height H [mm]	Diameter D [mm]	
		1 BSPP	2 BSPP	1	2	3	5	at 40 psi [US gal/min]			
180° 	577.283.1Y	AN	-	115	163	200	258	50	72	118	3.4
	577.363.1Y	AN	-	182	258	316	408	80	72	118	3.9
	577.403.1Y	-	AW	228	322	394	509	100	103	156	4.2
	577.433.1Y	-	AW	273	386	473	610	120	103	156	4.6
	577.523.1Y	-	AW	452	639	783	1,010	170	103	156	5.4
180° 	577.284.1Y	AN	-	115	163	200	258	50	72	118	3.4
	577.364.1Y	AN	-	182	258	316	408	80	72	118	3.9
	577.404.1Y	-	AW	228	322	394	509	100	103	156	4.2
	577.434.1Y	-	AW	273	386	473	610	120	103	156	4.6
	577.494.1Y	-	AW	380	538	659	851	170	103	156	5.4
270° 	577.285.1Y	AN	-	115	163	200	258	50	72	118	3.4
	577.365.1Y	AN	-	182	258	316	408	80	72	118	3.9
	577.405.1Y	-	AW	228	322	394	509	100	103	156	4.2
	577.435.1Y	-	AW	273	386	473	610	120	103	156	4.6
	577.495.1Y	-	AW	380	538	659	851	170	103	156	5.4
360° 	577.289.1Y	AN	-	115	163	200	258	50	72	118	3.4
	577.369.1Y	AN	-	182	258	316	408	80	72	118	3.9
	577.409.1Y	-	AW	228	322	394	509	100	103	156	4.2
	577.439.1Y	-	AW	273	386	473	610	120	103	156	4.6
	577.499.1Y	-	AW	380	538	659	851	170	103	156	5.4

NPT on request

The maximum tank diameter shown above applies for the recommended operating pressure and is indicative only. The cleaning result is also affected by the type of soiling.

### Information on operation

- Operation with compressed air only for short-term usage. Operation above the recommended operating pressure has negative effects on the cleaning result and wear.

Example for Ordering: Type 577.283.1Y. + Connection AN = Ordering no. 577.283.1Y.AN

